



Operation Manual

GEM and GEM PRO



GEM and GEM PRO

TABLE OF CONTENTS

- Manual guidelines 4
 - Notes and Hyperlinks 4
- Models 5
 - i-Q Series 5
 - Affinity..... 6
- Warnings 7
- KEY FEATURES 11
 - GEM vs GEM PRO..... 12
- OPERATION 13
 - i-Q Controls..... 13
 - Gas Ports and Connectors..... 14
 - Battery and Charger 15
 - Affinity (Wireless probe) 16
 - Connection..... 16
 - Starting the i-Q..... 18
 - Status LED 18
 - i-Q 18
 - Affinity..... 19
 - Main Reading Screen 19
 - Status Bar 20
 - Battery Remaining..... 20
 - Navigation and Display..... 20
 - Menu..... 20
 - Special Actions 23
 - ZOOM IN / OUT 23
- GAS SAMPLING 24
 - Best Practice 24
 - User Calibration 24
 - Affinity Pairing..... 26
 - Reading Process 26
 - Main Menu..... 26
 - Creating IDs in the field..... 26
 - Sampling from a QED Orifice Plate..... 26

Operation Manual
GEM and GEM PRO

Taking a reading..... 29

MAINTENANCE..... 31

Tools..... 31

i-Q Series..... 32

 Battery Pack Replacement..... 32

 Water Filters..... 33

 Modules..... 34

 Coin cell replacement (Energizer® CR2032, 3V)..... 38

Affinity..... 42

 Battery Replacement..... 42

 Cleaning and Decontamination..... 43

ACCESSORIES AND SPARES..... 44

 Modules..... 44

 Accessories..... 45

QUICK LINKS..... 47

 QED Downloads..... 47

 i-Q Help..... 47









 Patent Information..... 47

WARRANTY INFORMATION..... 48

GEM and GEM PRO

MANUAL GUIDELINES

Any general symbols used on the product can be found in the table below:

Symbol	Description	Symbol	Description
	By placing the CE marking on a product a manufacturer is declaring, on their sole responsibility, conformity with all of the legal requirements, and for the product to be sold within, the European Economic Area (EEA).		By placing the UKCA marking on a product a manufacturer is declaring, on their sole responsibility, conformity with all of the legal requirements, and for the product to be sold within the UK.
	The wheelie bin icon indicates that the product cannot be disposed of through general waste. Separate collection, handling and disposal of waste electrical and electronic equipment and its components is required.		General warning or hazard.
	Refer to Operator’s Manual.		For indoor use only.
	Symbol for ATEX certified equipment for potentially explosive atmospheres.		The symbol for IECEx certified equipment for potentially explosive atmospheres.
	Symbol of the agency that assessed the product to applicable standards. A “US” indicates the product meets the applicable US standards and a “C” indicates the product meets the applicable Canadian standards.		

NOTES AND HYPERLINKS

Note: This format shows important/useful information and instructions clearly throughout the manual.

Hyperlinks to other sections of this manual, websites, or email addresses will be shown clearly throughout the manual in this format: www.qedenv.com.

MODELS
 i-Q SERIES



i-Q™ GEM
 i-Q™ GEM PRO



Ex ib IIA T1 Gb
 (Ta = -10°C to +45°C)
 ExVeritas 23ATEX1559X
 ExVeritas 23UKEX1560X
 IECEx EXV 23.0013X



801503
 CLASS 1, ZONE 1, AEx ib
 IIA T1
 (Ta = -10°C to +45°C)



Figure 1 – i-Q Series Marking Plate

Specific Conditions of Use:
 None

Conditions of Acceptability:
 None

GEM and GEM PRO

AFFINITY



Affinity



2813



0518



Ex ib IIA T1 Gb
(Ta = -10°C to +50°C)
ExVeritas 23ATEX1396
ExVeritas 23UKEX1397
IECEX EXV 22.0051



801503
CLASS 1, ZONE 1, AEx ib
IIA T1
(Ta = -10°C to +50°C)

QED Environmental Systems

Connector	U _c	I _c	P _c	C _c	L _c	C _s	L _s
A	5V	5mA	7mW	0µF	0mH	500µF	500mH
B	8.6V	16mA	33mW	2µF	0mH	499µF	500mH
C	8.6V	3mA	6mW	0µF	0mH	500µF	500mH

WARNING: USE ONLY WITH ENERGIZER L91 BATTERIES, DO NOT REPLACE BATTERY WHEN AN EXPLOSIVE ATMOSPHERE IS PRESENT
ATTENTION: UTILISER UNIQUEMENT DES BATTERIES ENERGIZER L91, NE PAS REMPLACER LA BATTERIE SI ATMOSPHERE EXPLOSIVE
Ex ib IIA T1 Gb (Ta = -10°C to +50°C)
ExVeritas 22 ATEX 1396 / IECEX EXV 22.0051 / ExVeritas 22 UKEX 1397
ONLY AS TO INTRINSIC SAFETY, CLASS I, ZONE 1, AEx ib IIA T1 (Ta = -10°C to +50°C)

Model: **AFFINITY**
Serial Number: **V3XXXXXX**
Date of Manufacture: **DD/MM/YYYY**

Marking plate

Specific Conditions of Use:

None





Conditions of Acceptability:

This product is to be used with only AA Type Energizer® L91 Cells

WARNINGS

The following warnings are for this equipment's setup, use, maintenance, and repair. The exclamation point symbol alerts you to a general warning and the hazard symbols refer to procedure-specific risks. When these symbols appear in the body of this manual or on warning labels, refer back to these Warnings. Product-specific hazard symbols and warnings not covered in this section may appear throughout the body of this manual where applicable.

Failure to follow the correct information may result in physical injury which in some cases could be fatal. If the equipment is used in a manner not specified by the manufacturer, the protection provided by the equipment may be impaired.

 WARNING	
   	<p>FIRE AND EXPLOSION HAZARD</p> <p>The work area's flammable gases, such as methane, can ignite or explode. To help prevent fire and explosion:</p> <ul style="list-style-type: none">• Use equipment only in well-ventilated areas.• Eliminate all ignition sources; such as pilot lights or cigarettes.• Do not open the equipment in an explosive atmosphere.• Where hazardous gases are being used, the gas exhausted from the instrument must be piped to an area where it is safe to discharge the gas.• It is the responsibility of the operator to determine the protection concept and classification of equipment required for a particular application and whether these gases create a potentially explosive atmosphere.• Do not attempt to charge non-rechargeable batteries. <p>Static charge may build up on plastic parts during cleaning and could discharge and ignite flammable gases. To help prevent fire and explosion:</p> <ul style="list-style-type: none">• Do not clean with a dry cloth.

GEM and GEM PRO



WARNING



INTRINSIC SAFETY

Intrinsically safe equipment that is improperly used, maintained or connected to non-intrinsically safe equipment will create a hazardous condition and can cause a fire or explosion. Follow local regulations and the following safety requirements.

- Only use QED-approved components.
- The equipment may be used with flammable gases and vapors with apparatus group IIA and temperature class T1.
- The equipment can contain gas sensing heads for the detection of particular gases. The inclusion of a sensor does not infer that the equipment is suitable for the use of gases with a temperature class of less than T1.
- The i-Q Series is only certified for use in ambient temperatures in the range 14°F to 113°F (-10°C to +45°C) and should not be used outside this range.
- Affinity is only certified for use in ambient temperatures in the range 14°F to 122°F (-10°C to +50°C) and should not be used outside this range.
- The equipment must not be used in an atmosphere of greater than 21% oxygen.
- The equipment must not be used in atmospheric pressure outside of 800mbar to 1100mbar.
- Do not charge, recharge, or open in a potentially explosive atmosphere.
- For the i-Q Series Battery Pack (PMMPB), the maximum input voltage, U_m , at the battery connector shall not exceed 10.1V.
- Only battery charger type iQ-3.9 shall be used to recharge the battery pack PMMPB.
- Any damage to the equipment that could affect the integrity of the IP65 rating, must be reported to the manufacturer.

For i-Q only:

- Use only with battery pack QED PMMPB.
- Use only with Energizer® CR2032 battery (QED part number iQ-COINCELL).

For Affinity only:

- Use only Energizer® L91 batteries.
- Do not replace the battery when an explosive atmosphere is present.
- Do not attempt to charge non-rechargeable batteries.



WARNING



TOXIC FUMES HAZARD

The i-Q Series of gas instruments can be used for measuring gases from landfill sites and biogas plants. Toxic gases can cause serious injury or death if inhaled.

- Read Safety Data Sheets (SDSs) to know the specific hazards of the gases you are using.
- Ensure that users are adequately trained in the safety aspects of the gases being used and appropriate procedures are followed.
- Store hazardous gases in approved containers, and dispose of empty cylinders according to applicable guidelines.
- Ensure hazardous gases are exhausted from the instrument to an area where it is safe to discharge the gas.
- Hazardous gases may be exhausted from the instrument when purging with clean air. Ensure gases are exhausted to an area where it is safe to do so.
- When opening the instrument, do so in a well-ventilated area.



PERSONAL PROTECTIVE EQUIPMENT

Always wear appropriate personal protective equipment (PPE) when using the instrument. Protective equipment helps prevent serious injury, including long-term exposure and inhalation of toxic fumes. Given the applications of intended use, this protective equipment may include, but is not limited to:

- Protective eyewear.
- Hearing protection.
- Protective clothing, such as footwear, gloves, or hard-hat, should be identified through a full risk assessment.

GEM and GEM PRO



WARNING



EQUIPMENT MISUSE HAZARD

Misuse can cause death or serious injury.



- Do not use the equipment when fatigued or under the influence of drugs or alcohol.
- Do not exceed the working parameters outlined in the intrinsic safety warnings.
- The input pressure for the i-Q Series should not exceed +/- 500 mbar relative to atmospheric pressure and the output pressure should not exceed +/- 100 mbar relative to atmospheric pressure.
- Gas instruments are sensitive pieces of scientific equipment and must be treated as such. If the equipment is used in a manner not specified by the manufacturer, the protection provided by the instrument may be impaired.
- If the equipment is likely to be exposed to aggressive substances (e.g. acidic liquids, gases that may attack metals, or solvents that may affect polymeric materials) then it is the responsibility of the user to take suitable precautions. Contact QED or our distributor if there are concerns.
- Do not alter or modify the equipment outside of any instructions provided by QED.
- Only QED-approved components are to be used as replacement parts. Alternatives may void agency approvals and create safety hazards.
- The instrument has been designed to be used in explosive atmospheres as defined by the classification. The instrument can be configured to measure low levels of several gases, but may not be certified for use in potentially explosive atmospheres of these gases.
- Use the equipment only for its intended purpose. Contact QED or our distributors for information.
- Repair of this equipment shall be carried out following the applicable code of practice.
- Check equipment for damage before each use. Contact QED or our distributors if there are concerns.
- When the battery is ready for disposal, it must be disposed of under the ordinance of the local authority and not disposed of through general waste.
- Keep children and animals away from the work area.
- Comply with all applicable safety regulations.

Note: For further information please contact Technical Support at QED on:

QED Environmental Systems Ltd.

+44(0)333 800 0088

technical@qedenv.co.uk

QED Environmental Systems, Inc.

+1 (800) 624-2026

service@qedenv.com

Operation Manual

GEM and GEM PRO

KEY FEATURES



The Landtec i-Q series of gas instruments is a revolutionary change in portable gas analysis. Building upon the highly popular 5000 Series platform, the i-Q series introduces an intelligent modular design to deliver tangible benefits for your business:

- Hazardous area Zone 1 certified
- Modular components which the user can replace or upgrade in the field
- Hot swappable long-life Battery Pack
- Dedicated System Pressure port
- GAMSsoft PC Software for managing IDs, secure data downloads, firmware updates, and user administration
- Legacy probe support via Affinity (handheld wireless device)
- Backlit keypad and high-definition touchscreen
- Support for QED Orifice Plate Wellheads
- Waterproof and dustproof rated to IP65
- Add IDs in the field directly on the instrument (optional)
- Total wireless connectivity, using Wi-Fi, Bluetooth and Location



GEM and GEM PRO

GEM VS GEM PRO

Feature		
Max. 3 gases	<input checked="" type="checkbox"/>	<input type="checkbox"/>
Max. 7 gases	<input type="checkbox"/>	<input checked="" type="checkbox"/>
CO2 measurement	<input checked="" type="checkbox"/>	<input checked="" type="checkbox"/>
Peak CH4	<input checked="" type="checkbox"/>	<input type="checkbox"/>
Min. O2	<input checked="" type="checkbox"/>	<input type="checkbox"/>
Peak reading (ALL except O2)	<input type="checkbox"/>	<input checked="" type="checkbox"/>
Min. reading (O2 only)	<input type="checkbox"/>	<input checked="" type="checkbox"/>
Low flow borehole measurement (0-25l/hr)	<input type="checkbox"/>	<input type="checkbox"/>
Volume flow (m3/hr) and Energy (BTU) calculation	<input checked="" type="checkbox"/>	<input checked="" type="checkbox"/>
Volume flow (m3/hr) only	<input checked="" type="checkbox"/>	<input checked="" type="checkbox"/>
Balance Calculation	<input checked="" type="checkbox"/>	<input checked="" type="checkbox"/>
Residual N2 calculation	<input type="checkbox"/>	<input checked="" type="checkbox"/>
Gas reading only mode	<input type="checkbox"/>	<input type="checkbox"/>
Relative pressure reading	<input checked="" type="checkbox"/>	<input checked="" type="checkbox"/>
Previous reading - stored	<input type="checkbox"/>	<input type="checkbox"/>
Previous reading - ID	<input checked="" type="checkbox"/>	<input type="checkbox"/>
GPS tagging	<input type="checkbox"/>	<input checked="" type="checkbox"/>
Zero calibrate multiple gases	<input checked="" type="checkbox"/>	<input checked="" type="checkbox"/>
Span calibrate multiple gases	<input checked="" type="checkbox"/>	<input checked="" type="checkbox"/>
User Calibration recorded against an ID	<input type="checkbox"/>	<input checked="" type="checkbox"/>
GAMSoft connection	<input checked="" type="checkbox"/>	<input checked="" type="checkbox"/>
Bluetooth	<input checked="" type="checkbox"/>	<input checked="" type="checkbox"/>
Wi-Fi	<input checked="" type="checkbox"/>	<input checked="" type="checkbox"/>
Firmware update support	<input checked="" type="checkbox"/>	<input checked="" type="checkbox"/>
Event log	<input checked="" type="checkbox"/>	<input checked="" type="checkbox"/>
Borehole ID	<input checked="" type="checkbox"/>	<input checked="" type="checkbox"/>
ID questions	<input checked="" type="checkbox"/>	<input checked="" type="checkbox"/>
Site questions	<input checked="" type="checkbox"/>	<input checked="" type="checkbox"/>
ID routes	<input checked="" type="checkbox"/>	<input checked="" type="checkbox"/>
Alarms and targets	<input type="checkbox"/>	<input checked="" type="checkbox"/>
Add ID in field	<input type="checkbox"/>	<input checked="" type="checkbox"/>
Data logging	<input type="checkbox"/>	<input checked="" type="checkbox"/>
Affinity support	<input checked="" type="checkbox"/>	<input checked="" type="checkbox"/>
Temperature probe support	<input checked="" type="checkbox"/>	<input checked="" type="checkbox"/>
Anemometer (velocity and flow) support	<input checked="" type="checkbox"/>	<input checked="" type="checkbox"/>
Relative humidity support	<input type="checkbox"/>	<input type="checkbox"/>
Touchscreen	<input checked="" type="checkbox"/>	<input checked="" type="checkbox"/>
Backlit keypad	<input checked="" type="checkbox"/>	<input checked="" type="checkbox"/>
User-replaceable, rechargeable battery	<input checked="" type="checkbox"/>	<input checked="" type="checkbox"/>
Local language (limited)	<input checked="" type="checkbox"/>	<input checked="" type="checkbox"/>
Hazardous area approval (ATEX, SGS)	<input checked="" type="checkbox"/>	<input checked="" type="checkbox"/>

OPERATION
 i-Q CONTROLS



Figure 2 – i-Q Controls

Reference	Description	Reference	Description
1	Power on/off	7	Touchscreen on/off
2	Help	8	Cursor keys
3	Menu	9	Select key
4	Exit	10	Status indicator LED
5	Accept / Next	11	Side Hotkeys
6	Pump on/off	12	5" color touchscreen

GEM and GEM PRO

GAS PORTS AND CONNECTORS



Figure 3 – i-Q Features

Reference	Description	Reference	Description
1	Gas Inlet / Static Pressure	6	Battery pack
2	Differential Pressure	7	Rear case
3	System Pressure	8	Stylus and holder recess
4	Gas outlet	9	Stylus tether anchor point
5	Charging socket	10	I/O plate

BATTERY AND CHARGER



To prevent fire and explosion:

- Do not charge or open in a hazardous or potentially explosive area.
- Battery Pack QED PMMPB is only for use with i-Q Series.
- Do not attempt to charge non-rechargeable batteries, for example, the Affinity batteries.

Power Supply	Description
Battery Type	Rechargeable nickel metal hydride battery pack (user replaceable)
Battery Life	Typical use 10 hours from fully charged
Battery charger	Separate intelligent 3A battery charger powered from the mains supply (100-240VAC)
Charger connector type	2-pin ODU
Charge time	Approximately 4 hours from complete discharge
Charging mode	Connected to the instrument, or standalone

- The PMMPB batteries used are nickel metal hydride and manufactured as a user-replaceable pack containing six individual cells and a PCB.
- The i-Q Series is supplied with a rechargeable battery pack (QED part number PMMPB). Charging of the battery pack can be undertaken while the battery is fitted or removed from the instrument. To charge the battery pack, QED charger iQ-3.9 must be used and charging must be in a safe area.
- Charge only with QED Charger part number iQ-3.9.
- A full charge will take approximately 4-hours.

To charge the battery pack, align the red dot on the charger plug with the red dot on the battery pack socket and plug in until you feel and hear the click of the latching mechanism – see annotation in [Figure 4](#).

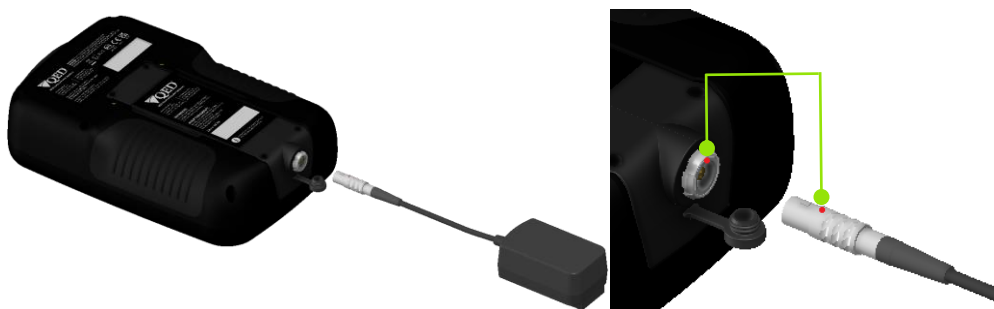

Figure 4 – Charger connection

Note: If the PMMPB battery is removed, the backup coin cell will maintain time/date settings and CO (H₂ compensated) cell conditioning for approximately 10 minutes. After this time, the user will have to reset the time & date and CO (H₂ compensated) cell conditioning will be affected, meaning the user may need to allow the cell to stabilize for 24 hours before use.

GEM and GEM PRO

AFFINITY (WIRELESS PROBE)



To prevent fire and explosion:

- Do not open in a hazardous or potentially explosive area.
- Eliminate all ignition sources; such as pilot lights or cigarettes.
- Only use AA Type Energizer® L91 batteries.
- Do not attempt to charge non-rechargeable batteries, for example, the Affinity batteries.



[iQV11](#)

Various peripherals can be connected to Affinity to measure different parameters, but these peripherals may not be certified or certified appropriately for use in potentially explosive atmospheres. It is the responsibility of the operator to determine the protection concept and classification of equipment required for a particular application and whether these peripherals are suitable for use in a potentially explosive atmosphere.

The instrument has been designed to be used with peripheral accessories that can be connected to the three connection sockets on Affinity, namely Temperature Probe, Anemometer, and Humidity Probe. The entity parameters for these sockets is as follows:

Connector	Uo	Io	Po	Ci	Li	Co	Lo
A – Temperature Probe	5V	5mA	7mW	0μF	0mH	500μF	500mH
B – Humidity Probe	8.6V	16mA	33mW	2μF	0mH	499μF	500mH
C – Anemometer Probe	8.6V	3mA	6mW	0μF	0mH	500μF	500mH

CONNECTION

Affinity connects to the i-Q Series by Bluetooth. To turn Affinity on, press and hold the power key, see Annotation 2 on [Figure 5 – Affinity](#), for two seconds. Pairing is done through the i-Q instrument.

GEM and GEM PRO



Figure 5 – Affinity

Reference	Description	Reference	Description
1	Status indicator LED	4	Battery Cover
2	Power on/off (2-second press)	5	Batteries (AA Energizer® Lithium L91)
3	Protective caps		

GEM and GEM PRO

STARTING THE i-Q



🔍 iQV03

- 1) Power on the i-Q by holding the power key for 2 seconds.

Note: You may be prompted to set the Time and Date if it is the instrument's first turn-on or the battery has been disconnected for more than 10 minutes.

- a. Time and date can be set from timezone and GNSS location (e.g. GPS) or set manually

- 2) A self-test will commence and assess the instrument.

Note: If there are any faults during Self-Test, select the Help key  for assistance.





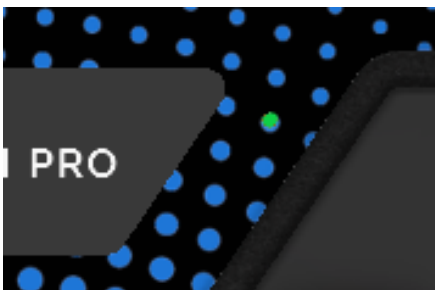

- 3) If Technician Login is enabled, the user will need to select their profile and if applicable, enter their password, before proceeding to the [Main Reading Screen](#).

STATUS LED

The status LED gives an indication of i-Q or Affinity condition while in its on state.

i-Q



Sequence	Color	Status
	Purple	Self-Test in progress
	Green	Self-Test pass
	Red	Self-Test fail
	Blue flashing	Recovery mode
	Red flashing	Critical battery
	Red rapid flashing	Critical shutdown
	Red, Green, Blue	Firmware update in progress

AFFINITY



Sequence	Color	Status
	Green flashing	Discovery mode
	Blue flashing	Paired with device
	Red flashing	Low battery
	Red rapid flashing	Critical battery
	Yellow	Firmware update in progress

MAIN READING SCREEN

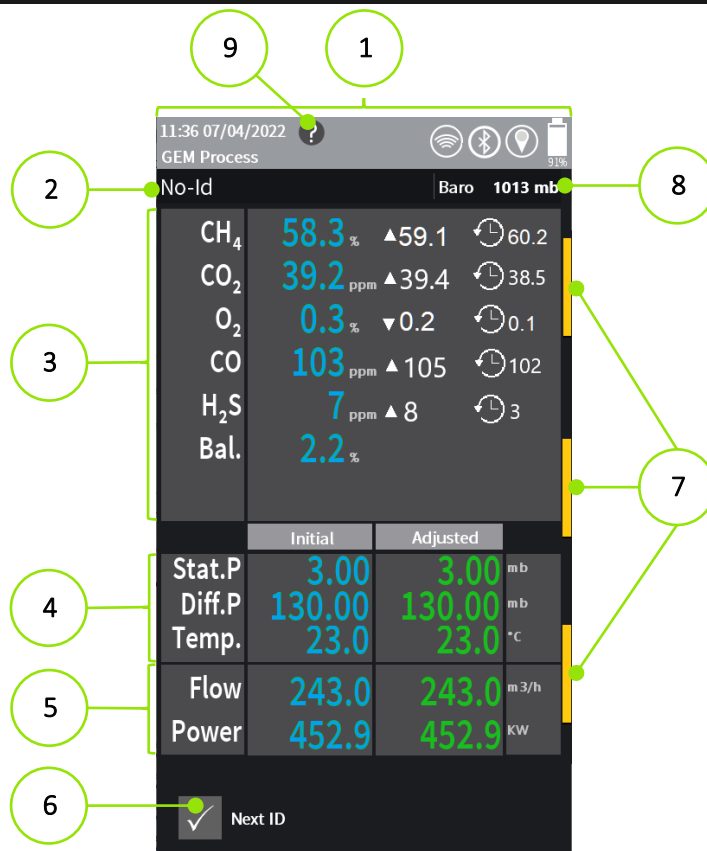

Figure 6 – i-Q GEM Reading Screen

Reference	Description	Reference	Description
1	Status bar	6	Next ID selection
2	Current sampling ID	7	Side Hotkey indicator
3	Gas composition	8	Ambient barometric pressure
4	Pressure and Temperature values	9	Help icon (if available)
5	Flow and Power values		

GEM and GEM PRO

STATUS BAR

The Status Bar has icons that give indications of warnings, errors, and other useful or important information:

Icon	Description	Reference	Description
	Help screen available		WIFI strength
	Memory: low / critical / full		Location: unknown / strength
	Pump flow: OK / Failed		Touchscreen disabled
	Over-pressurization warning		
	Bluetooth: on / connected / Affinity battery low		
	Battery: low / good / error / charging (% shown)		

BATTERY REMAINING

Battery life is displayed in the top right corner of the display and includes a % remaining. In addition, pressing the battery icon will display a window that provides additional information to the user:

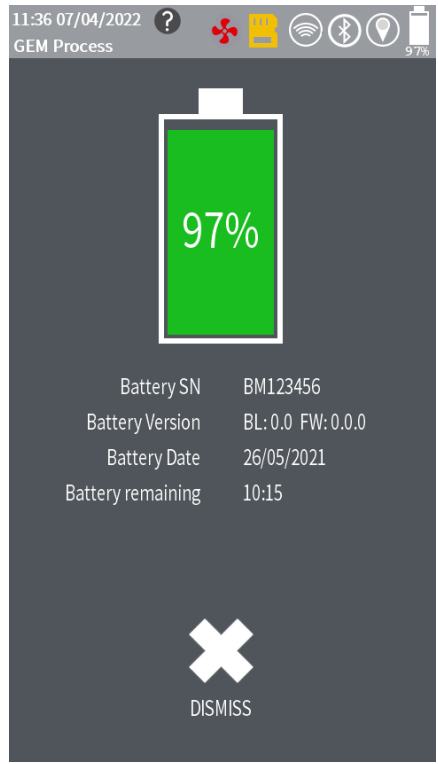

NAVIGATION AND DISPLAY MENU

Access the main menu from the keypad menu key or by pressing the Status Bar.

Use the touchscreen, keypad Side Hotkeys or directional arrows to select menu tiles.

Screens with Side Hotkey options are indicated by a thin vertical yellow bar on the left or right edge of the screen. Touch the edge of the screen or any corresponding side key to bring up the options.

Some of the common menus and submenu icons are listed below:

Operation Manual

GEM and GEM PRO

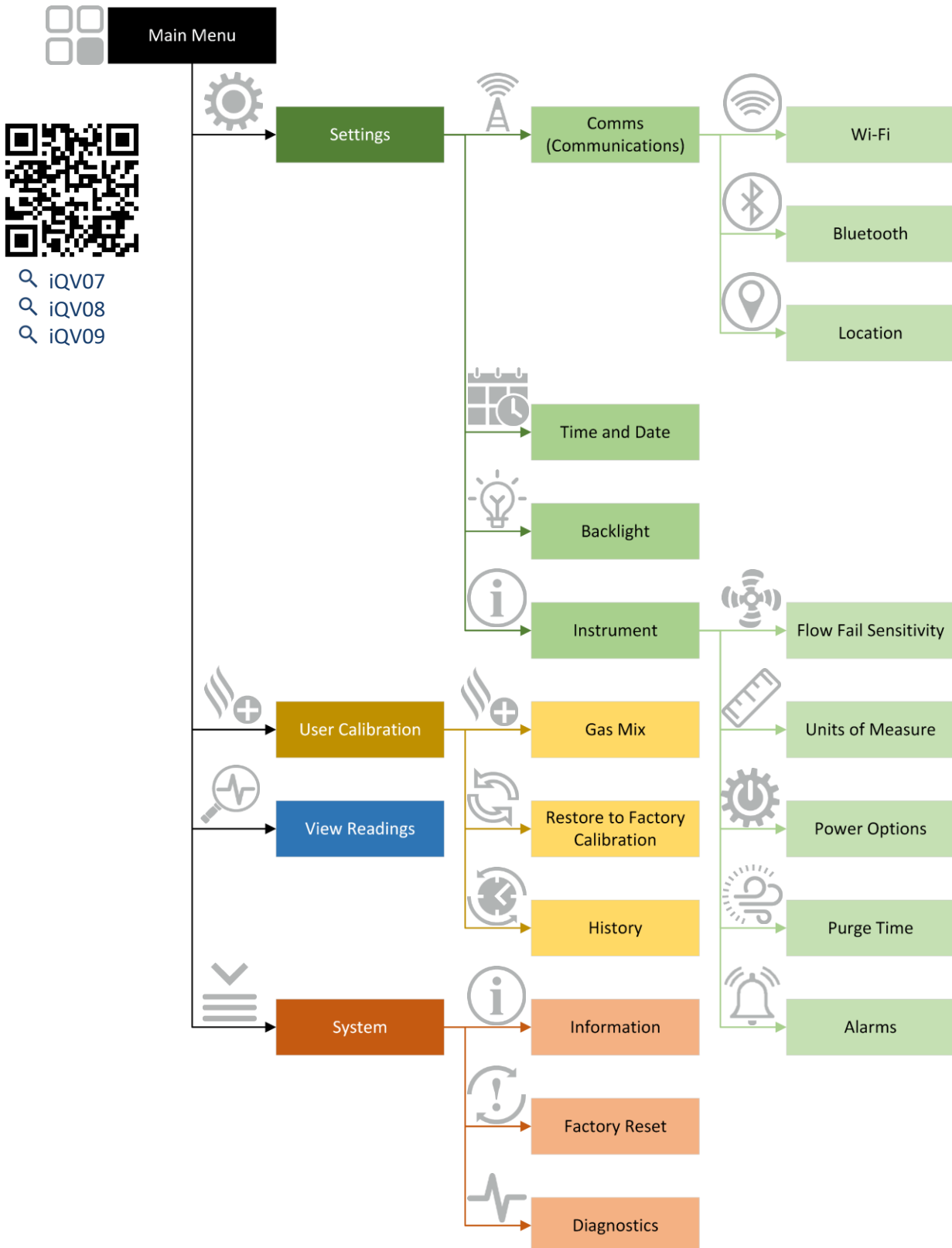

GEM and GEM PRO



iQV10



ID Menu

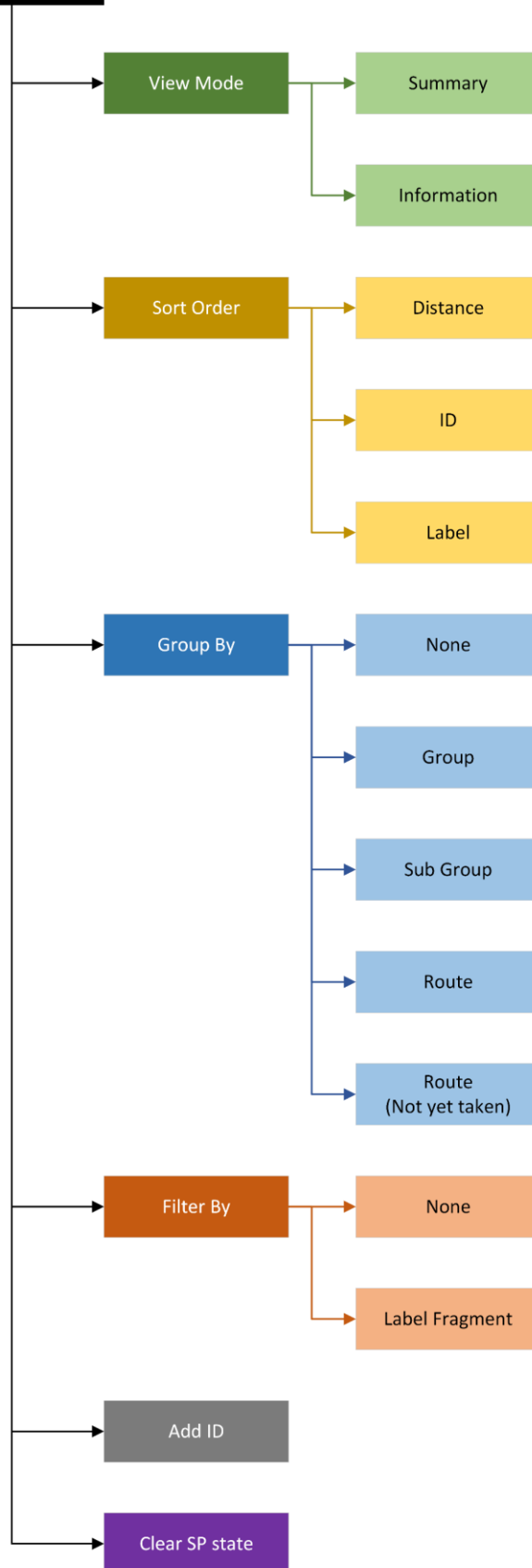

SPECIAL ACTIONS

During a reading process, Specials Actions are accessed from the right-side hotkeys. They include:

- Restart Process
- Take System Pressure
- Answer Questions
- Use Inline Filter
- Zero transducers
- Enter Temp(erature)
- Enter Flow

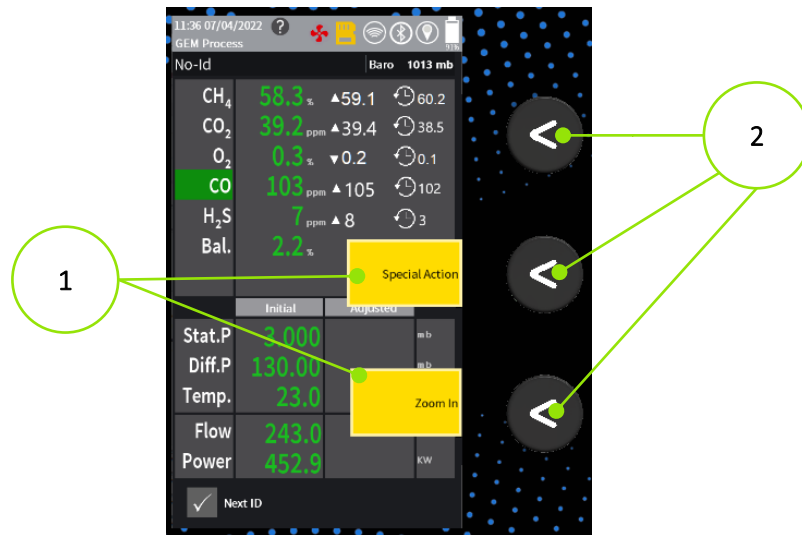

Reference	Description
1	Hot Key options
2	Side Hot Key

ZOOM IN / OUT

During a reading process, Zoom In / Out is accessed from the right-side hotkeys. Toggle between Gases and Flow readings using the right-side hotkey.

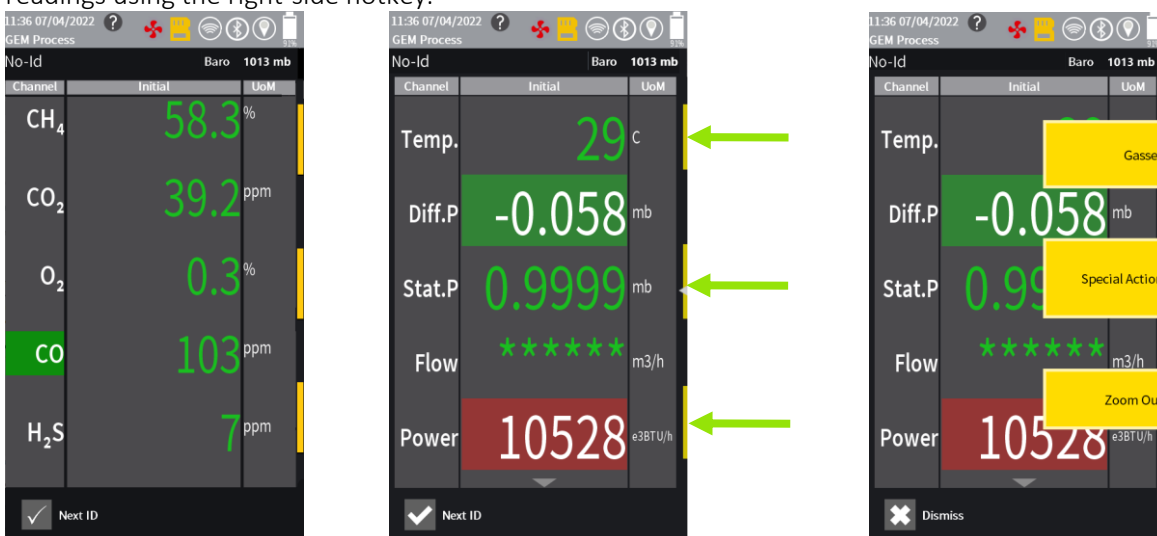

GEM and GEM PRO

GAS SAMPLING

BEST PRACTICE



🔍 iQV05

- 1) Use an in-line 'water trap' on the inlet tube to avoid liquid entering the i-Q
- 2) Change the internal PTFE filters as required as part of a regular maintenance schedule, see [Water Filters](#).
- 3) Use an in-line (H₂S/Hydrocarbon) filter to remove potential cross-gas effects (e.g. CO gas), if required.
- 4) Regularly calibrate gas channels, see [User Calibration](#).

USER CALIBRATION



To prevent fire and explosion:

- Do not charge or open in a hazardous or potentially explosive area.
- Eliminate all ignition sources; such as pilot lights or cigarettes.

To prevent inhalation of harmful gases:

- Read Safety Data Sheets (SDSs) to know the specific hazards of the gases you are using.
- Ensure that users are adequately trained in the safety aspects of the gases being used and that appropriate procedures are followed.
- Store hazardous gases in approved containers, and dispose of empty cylinders according to applicable guidelines.
- Ensure hazardous gases are exhausted from the instrument to an area where it is safe to discharge the gas.
- Hazardous gases may be exhausted from the instrument when purging with clean air. Ensure gases are exhausted to an area where it is safe to do so.



🔍 iQV06

The i-Q modules are carefully calibrated at manufacture using several gas concentrations and temperature points. However, it is sometimes desirable to carry out a gas check on the equipment to prove its accuracy and rectify any inaccuracies with a calibration process.

Operation Manual

GEM and GEM PRO

You can edit and create custom gas mixtures directly on the i-Q or upload from GAMSoft.

Select 'User Calibration' from the main menu.

Gas Mix – Select gas mix, edit and start calibration

Restore to Factory Calibration – Removes user calibration and returns to factory settings

History – Shows previous calibration results

[Flow Chart 1](#) depicts the process for user calibration options.

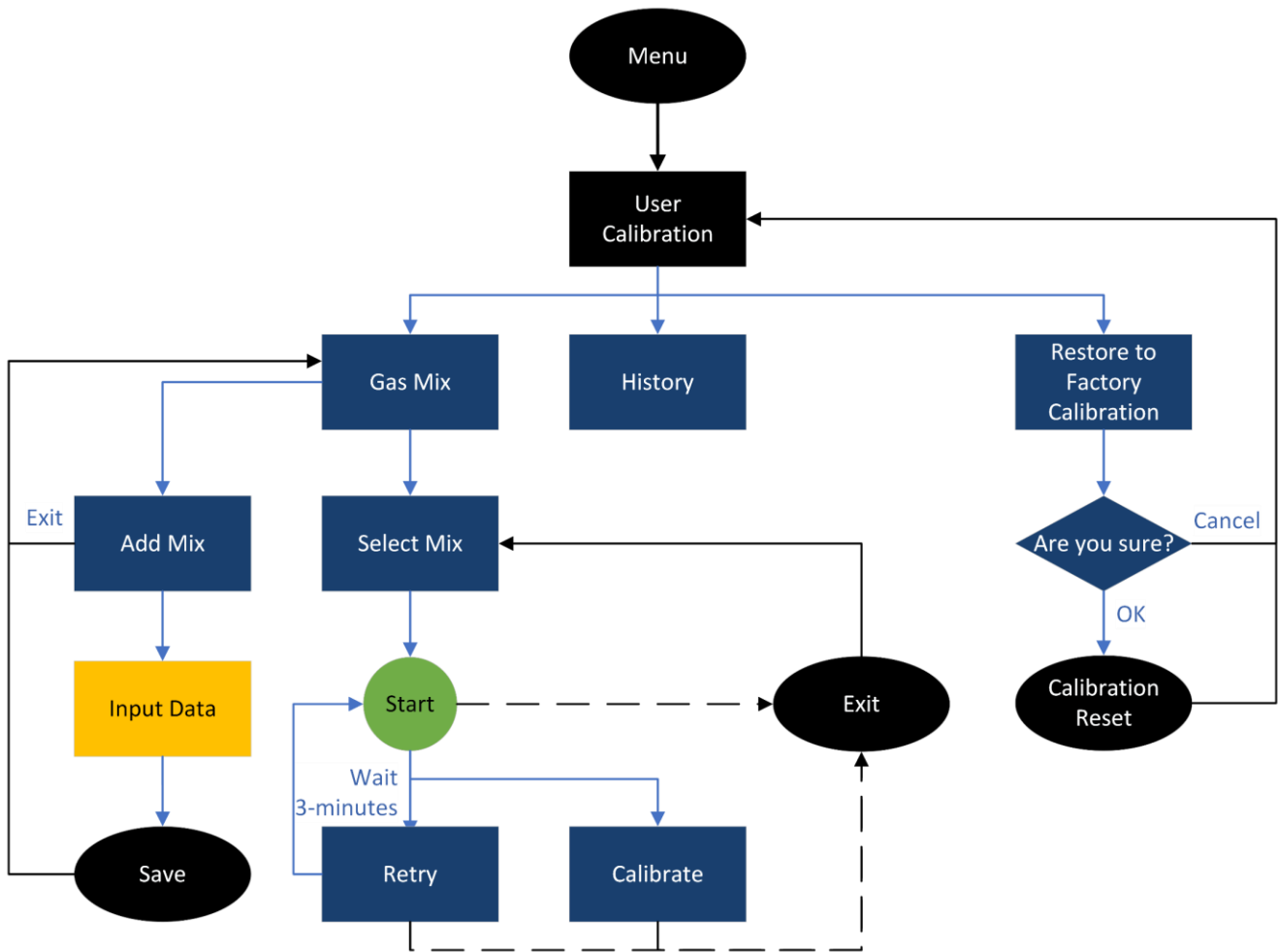

Flow Chart 1

GEM and GEM PRO

AFFINITY PAIRING



🔍 iQV11

To pair the i-Q and the “Affinity” handheld wireless device, there are two available methods:

READING PROCESS

- 1) Power on the Affinity by holding the power key for 2 seconds. The status LED will blink green.
- 2) During the gas sampling stage ‘Initial Values’, the i-Q will automatically search for Affinity devices in range.
- 3) Select the Affinity to pair with it from the list of discovered devices

Note: If ‘Auto Connect’ is selected, the i-Q device will automatically connect to that Affinity device in the future.

MAIN MENU

- 1) Power on the Affinity by holding the power key for 2 seconds. The status LED will blink green.
- 2) From the Main Reading Screen, press the menu key 
- 3) Select “Settings” → “Comms” → “Bluetooth”
- 4) Ensure Bluetooth is turned on
- 5) Press “Scan” and the i-Q will search for Affinity devices in range.
- 6) Select the Affinity to pair with from the list of discovered devices and press “Connect”





CREATING IDs IN THE FIELD

To create IDs on the i-Q you must have an existing Site and Group (previously uploaded from GAMSoft software).

- 1) Select Next ID, then select the menu key 
- 2) Scroll down to select the option ‘Add ID’
- 3) Populate all mandatory fields and select Save.

Note: If adding an ID in the field, when downloading readings in GAMSoft, you will be asked whether you would like to include this new ID in your site.

SAMPLING FROM A QED ORIFICE PLATE

				
<p>To prevent fire and explosion:</p> <ul style="list-style-type: none">• Do not charge or open in a hazardous or potentially explosive area.• Eliminate all ignition sources; such as pilot lights or cigarettes. <p>To prevent inhalation of harmful gases:</p>				

Operation Manual

GEM and GEM PRO

- Read Safety Data Sheets (SDSs) to know the specific hazards of the gases you are using.
- Ensure that users are adequately trained in the safety aspects of the gases being used and appropriate procedures are followed.
- Store hazardous gases in approved containers, and dispose of empty cylinders according to applicable guidelines.
- Ensure hazardous gases are exhausted from the instrument to an area where it is safe to discharge the gas.
- Hazardous gases may be exhausted from the instrument when purging with clean air. Ensure gases are exhausted to an area where it is safe to do so.

[Figure 7](#) best describes the setup for connecting an i-Q instrument to a QED Wellhead with QED Orifice Plates.

Note: Other wellheads and flow devices may require a different setup arrangement. For further information please contact Technical Support at QED on:

QED Environmental Systems Ltd.

+44(0)333 800 0088

technical@qedenv.co.uk

QED Environmental Systems, Inc.

+1 (800) 624-2026

service@qedenv.com

GEM and GEM PRO



Figure 7 – i-Q Setup

TAKING A READING



To prevent fire and explosion:

- Do not charge or open in a hazardous or potentially explosive area.
- Eliminate all ignition sources; such as pilot lights or cigarettes.

To prevent inhalation of harmful gases:

- Read Safety Data Sheets (SDSs) to know the specific hazards of the gases you are using.
- Ensure that users are adequately trained in the safety aspects of the gases being used and appropriate procedures are followed.
- Store hazardous gases in approved containers, and dispose of empty cylinders according to applicable guidelines.
- Ensure hazardous gases are exhausted from the instrument to an area where it is safe to discharge the gas.
- Hazardous gases may be exhausted from the instrument when purging with clean air. Ensure gases are exhausted to an area where it is safe to do so.



🔍 iQV10

[Flow Chart 2](#) depicts the process for taking a reading on the i-Q.

Note: IDs are added to the instrument using GAMSsoft or created on the instrument providing a site is already present, see [Creating IDs in the field](#).

Note: Once a reading is stored against an ID, the ID will have a ~~strike through~~ in the ID list to indicate to the user that this ID has been taken.

Note: Use of Affinity is optional but results in manual temperature entry if not used. To pair Affinity, see [Affinity Pairing](#).

Note: If Affinity is used once, it is assumed it is used for all readings unless defined by GAMSsoft or disconnected.

Note: Site Questions and ID questions are optional and set in GAMSsoft.

Note: System Pressure is set in GAMSsoft and is optional for an ID.

Note: [Special Actions](#) can be accessed at any time by pressing any right-side Hotkey, or pressing the touchscreen along the right edge of the display. The Special Actions available will be dependent on where in the process you are.

GEM and GEM PRO

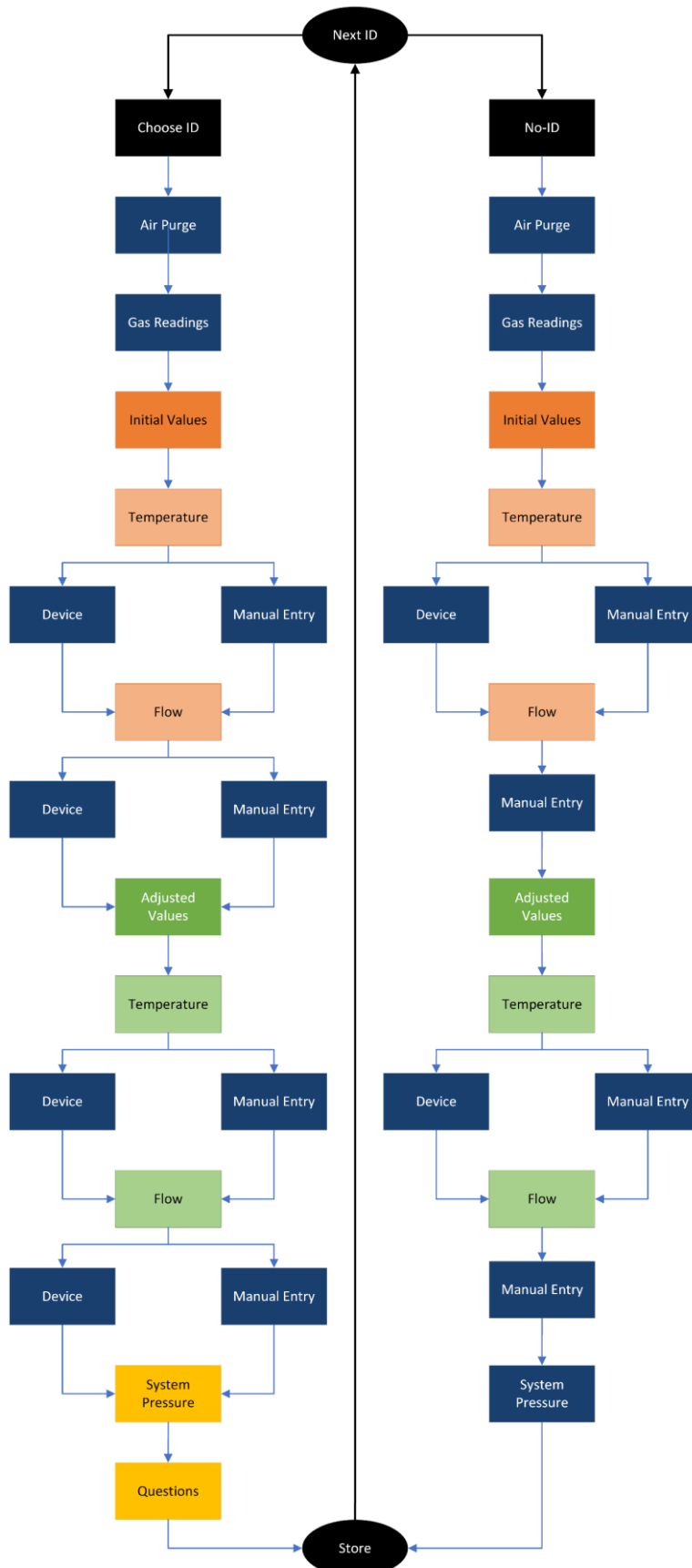

Flow Chart 2

MAINTENANCE



To prevent fire and explosion:

- Do not open in a hazardous or potentially explosive area.
- Only use QED Battery PMMPB for i-Q.
- Use only Energizer® CR2032 (QED part number iQ-COINCELL) for backup battery replacement.
- Only use AA Type Energizer® L91 batteries for Affinity.
- Do not attempt to charge non-rechargeable batteries.

To avoid misuse hazards:

- Do not alter or modify the equipment outside of any instructions provided by QED.
- Only QED-approved components are to be used as replacement parts. Alternatives may void agency approvals and create safety hazards.
- Repair of this equipment shall be carried out following the applicable code of practice.
- When the battery is ready for disposal, it must be disposed of under the ordinance of the local authority and not disposed of through general waste.
- Comply with all applicable safety regulations.

To avoid toxic fume hazards:

- Open in a well-ventilated area.

Note: For further information please contact Technical Support at QED on:

QED Environmental Systems Ltd.

+44(0)333 800 0088

technical@qedenv.co.uk

QED Environmental Systems, Inc.

+1 (800) 624-2026

service@qedenv.com

TOOLS

The i-Q comes supplied with a multi-use tool. This tool can be used on the screws for the i-Q battery, case back, and modules. The driver bit is double-ended and is a Phillips No. 1 and Slotted No. 4.5mm:



Figure 8 – Multi-use Tool

GEM and GEM PRO

i-Q SERIES

Note: The i-Q Series consists of many replaceable parts. Any replaceable part must be supplied by QED or an authorized representative and will come with a specific set of instructions for its replacement. For technical support, please contact QED or an authorized representative.

For further help, please refer to our i-Q Help Page:



BATTERY PACK REPLACEMENT



🔍 iQV14

The i-Q battery pack is user replaceable. It can be changed quickly and easily while in the field, including when in a hazardous area. To replace the battery:

- 1) Ensure the instrument is switched off.
- 2) Using the supplied tool, select the Phillips No. 1 screwdriver and unscrew the four battery pack screws and remove them from the case back – see [Figure 9](#).

Note: The battery pack screws are retaining and should remain part of the pack.



Figure 9 – Battery Removal

- 3) Place the replacement battery pack (QED part number PMMPB) into the case back recess. It will only fit one way and will automatically align itself.
- 4) Using the supplied tool, select the Phillips No. 1 screwdriver, and secure the battery pack in place.
- 5) i-Q is now ready to be switched on and used.

Note: If the PMMPB battery is removed, the backup coin cell will maintain time/date settings and CO (H₂ compensated) cell conditioning for approximately 10 minutes. After this time, the user will have to reset the time & date and CO (H₂ compensated) cell conditioning will be affected, meaning the user may need to allow the cell to stabilize for 24 hours before use.

Note: It is the operator's responsibility to keep a record of when and what maintenance has been performed.

Operation Manual

GEM and GEM PRO

Note: In the event of malfunction or damage, please contact QED or an authorized representative.

Note: For further information please contact Technical Support at QED on:

QED Environmental Systems Ltd.

+44(0)333 800 0088

technical@qedenv.co.uk

QED Environmental Systems, Inc.

+1 (800) 624-2026

service@qedenv.com

WATER FILTERS



🔍 iQV14

Each inlet port has a PTFE filter to stop liquid from entering the instrument:

- 1) Using the supplied tool, select the Phillips No. 1 screwdriver and unscrew the 4 faceplate screws
- 2) Gently lift the faceplate away from the case, whilst keeping it parallel to the top of the case

Note: Filters firmly located in the i-Q body can be removed using the supplied filter removal tool.

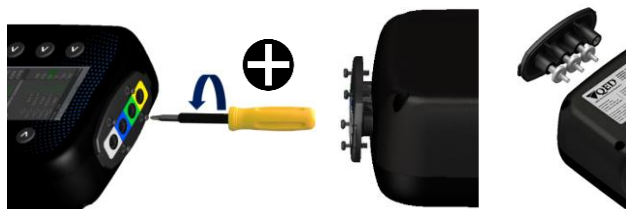

- 3) Replace the filters by placing them inside the faceplate.
- 4) To reassemble, follow the above steps in reverse order, paying attention to the good fit of mating components and taking care not to overtighten any screws.

GEM and GEM PRO

MODULES



🔍 iQV15

CASE BACK REMOVAL



To prevent inhalation of harmful gases:

- All module bays must have a module or bypass module present.

The i-Q instrument contains modules that can be changed by the customer without the need to return the instrument for servicing or replacement. To access these modules, follow this procedure:

- 1) Place the instrument face down on a suitable surface
- 2) Using the supplied tool, select the Phillips No. 1 screwdriver and unscrew the four screws holding the battery
- 3) Remove the battery
- 4) Using the supplied tool, select the Phillips No. 1 screwdriver and unscrew the four screws holding the I/O plate at the top of the instrument
- 5) Gently lift the faceplate away from the case, while keeping it parallel to the top of the case

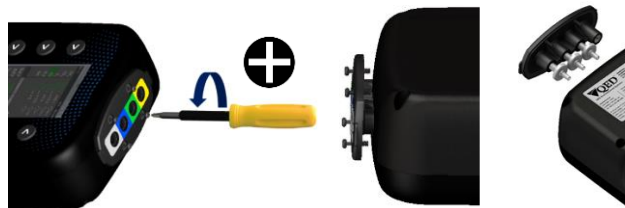

Figure 10 – Inlet Port Plate Removal

Operation Manual

GEM and GEM PRO

- 6) Using the supplied tool, select the Phillips No. 1 screwdriver and remove the 8 screws from the case back and gently remove the case back from the case front to have access to the internals of the i-Q.



Figure 11 – Case Back Removal

- 7) To reassemble, follow the above steps in reverse order, paying attention to the good fit of mating components and taking care not to overtighten any screws.

Note: When the battery pack is removed, the internal coin cell battery will retain the current time & date and compensated cell bias for a short time only. Aim to complete maintenance activities within 10 minutes if possible.

GEM and GEM PRO

MODULE BAY POSITIONS

Some modules must always be located in a particular bay, whilst others can fit in multiple bay positions. The bay numbers are indented on the plastic beside each bay position. Use the guide below when changing modules.

Infrared Bench Module

Bays 1 & 2

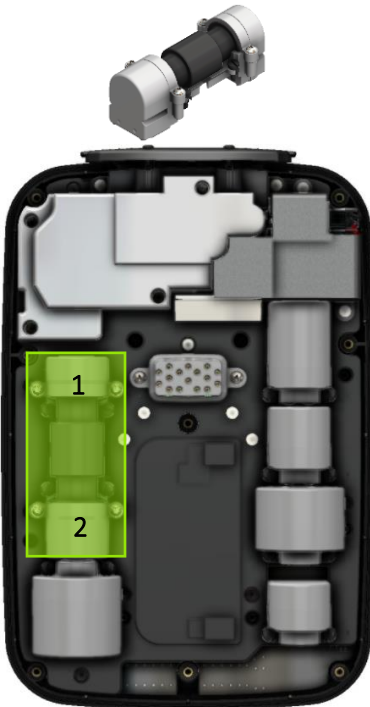

CO/H₂ Compensated Module

Bay 3

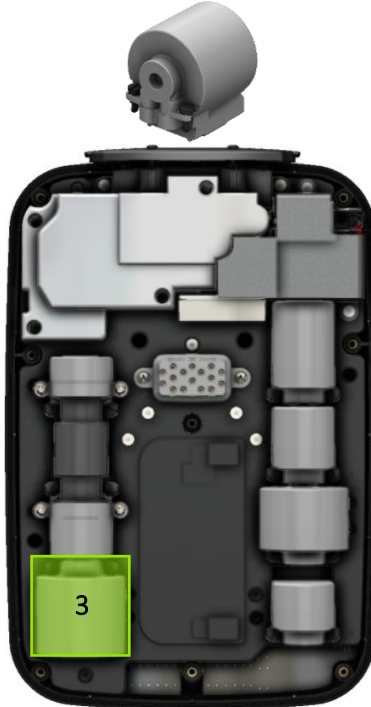

Oxygen Module

Bay 4



Electrochemical Cell and Bypass Modules

Bays 1 – 7

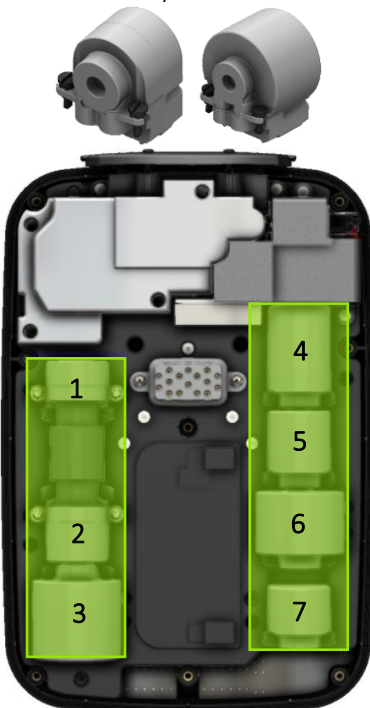

Pressure Module

Bay 8



REPLACEMENT PROCESS

REMOVAL

The modules are locked in position using ¼ turn locking screws, as indicated by the information label, *see below*. Modules in the locked position are identified by screw head slots in the vertical orientation. Modules in the unlocked position are identified by screw head slots in the horizontal orientation.

- 1) Using the supplied tool, select the Slotted No 4.5mm screwdriver and turn the locking screws anti-clockwise a ¼ turn.
- 2) Carefully but firmly lift the module upwards.

Note: Only turn the module locking screws ¼ turn. Do not over-rotate.

Note: The pressure module has no locking screws and can be gently lifted upwards.

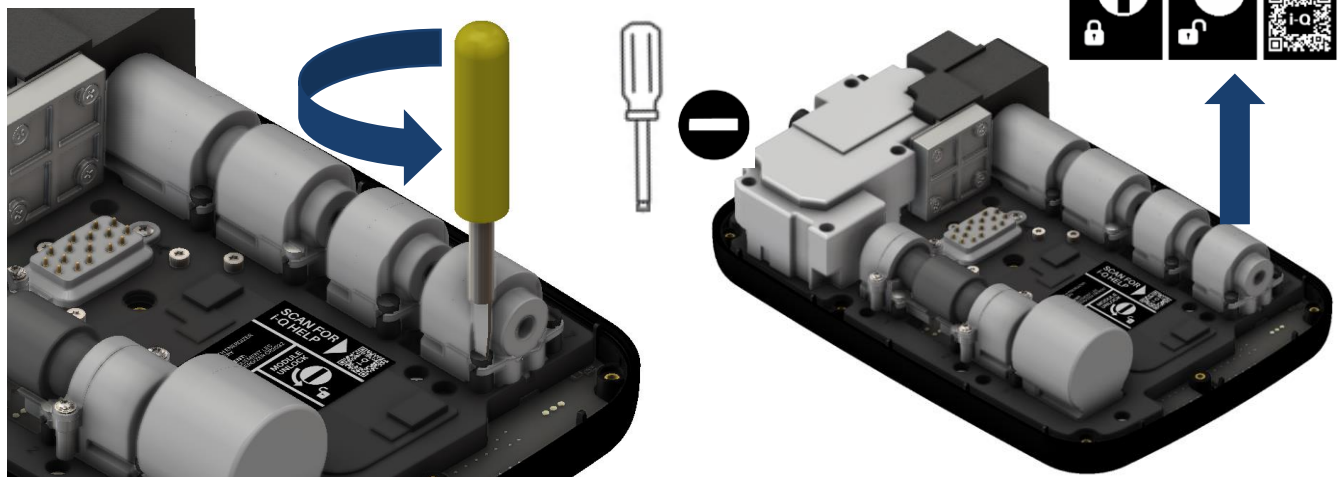

REPLACEMENT



To prevent inhalation of harmful gases:

- All module bays must have a module present.
- Ensure modules are located correctly and correctly tightened using the ¼-turn locking screw.

- 1) Ensure the module screws are in the unlocked position (horizontal).
- 2) Rest the module above the empty bay in the correct orientation, ensuring that the module pins correspond with the gold pads on the board.

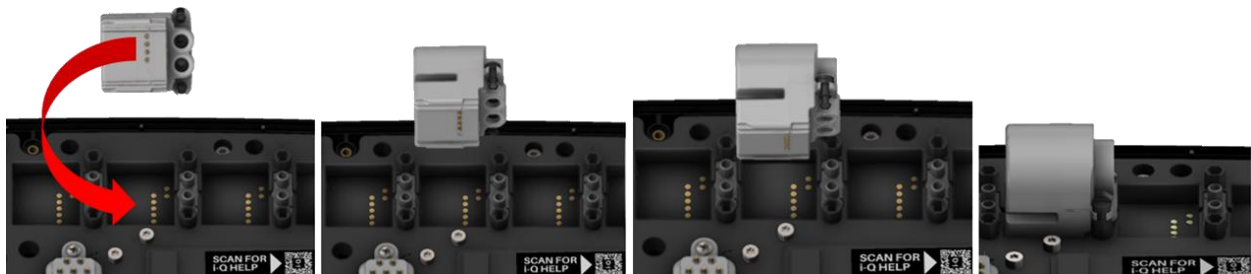



GEM and GEM PRO

- 3) Gently push the module down until the locking screw brackets on the module are flush against the pillars of the instrument manifold.
- 4) Using the supplied tool, select the Slotted No 4.5mm screwdriver and turn the locking screws clockwise a 1/4 turn.

Note: The pressure module has no locking screws. Align the 4-pin electrical connector and gas ports with the base and apply a gentle but firm downward pressure to secure; see [Figure 17](#).

COIN CELL REPLACEMENT (ENERGIZER® CR2032, 3V)

				
<p>To prevent fire and explosion:</p> <ul style="list-style-type: none">• Do not open in a hazardous or potentially explosive area.• Use only Energizer® CR2032 (QED part number iQ-COINCELL) for backup battery replacement. <p>To avoid misuse hazards:</p> <ul style="list-style-type: none">• Do not alter or modify the equipment outside of any instructions provided by QED.• Only QED-approved components are to be used as replacement parts. Alternatives may void agency approvals and create safety hazards.• Repair of this equipment shall be carried out following the applicable code of practice.• When the battery is ready for disposal, it must be disposed of under the ordinance of the local authority and not disposed of through general waste.• Comply with all applicable safety regulations.• It is the operator’s responsibility to keep a record of when and what maintenance has been performed.• In the event of malfunction or damage, please contact QED or an authorized representative.				



[iQV15](#)

The internal coin cell battery will retain the current time & date and compensated cell bias for a short time if the primary battery pack is removed. If the coin cell registers as “missing” due to insufficient charge, it should be replaced.

To replace the coin cell:

- 1) Using the supplied Phillips No. 1 screwdriver, unscrew the four battery pack screws and remove them from the case back – see [Figure 9](#).

Note: The battery pack screws are retaining and should remain inside the pack.

- 2) Using the Phillips No. 1 screwdriver, loosen the inlet port plate screws and gently ease from the case assembly using the plate ears, see [Figure 12](#).

Note: The plate only needs loosening and does not require removal.

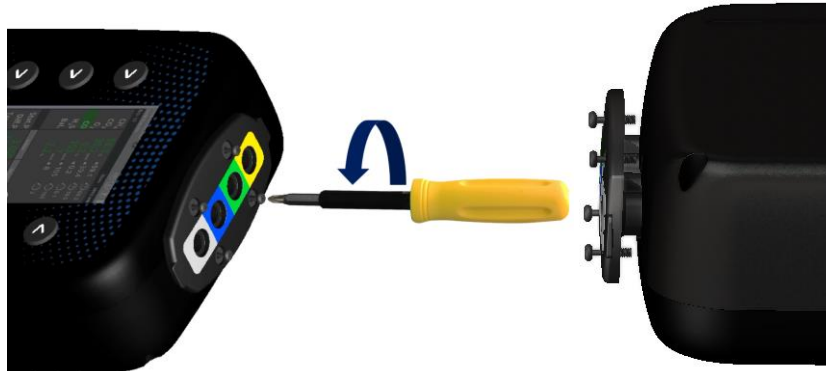

Figure 12 – Inlet Port Plate Removal

- 3) Using the Phillips No. 1 screwdriver, remove the 8 screws from the case back and gently remove the case back from the case front to have access to the internals of the i-Q.



Figure 13 – Case Back Removal

Note: Internals of i-Q will vary depending on the configuration.

Note: The case back screws are retaining and should remain inside the case back.

GEM and GEM PRO

- 4) Simply lift the pressure module from its location (Bay 8, see [Module bay positions](#)) to gain access to the coin cell – see annotation 1 in [Figure 14](#).

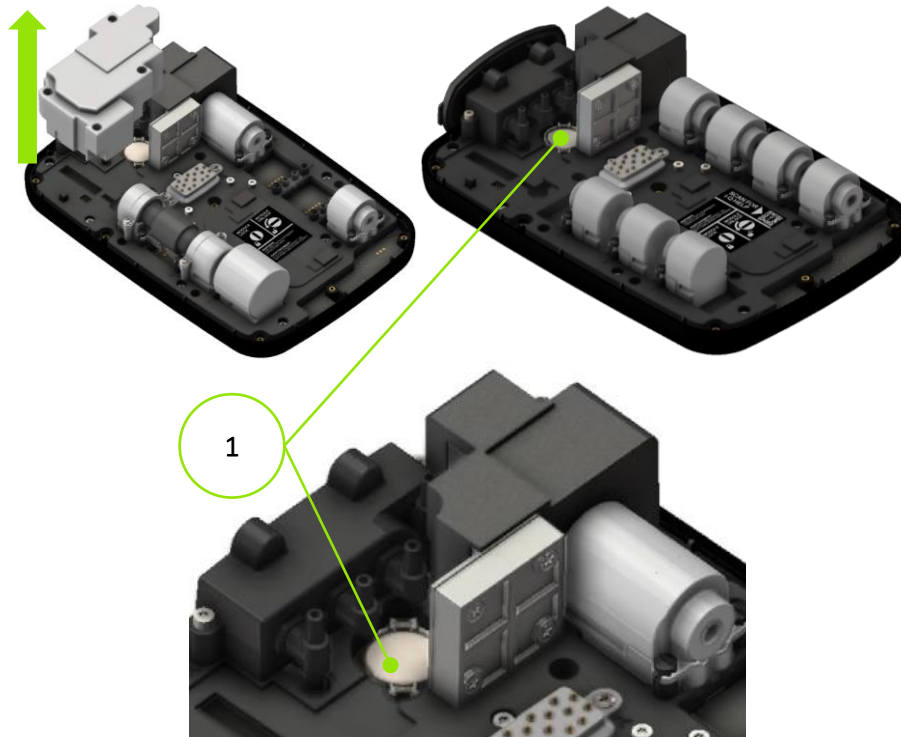

Figure 14 – Pressure Module Removal

- 5) Using the spudger supplied with the replacement coin cell, lift the old coin cell out of its cradle



Figure 15 – Coin Cell Removed

- 6) Fit the new coin cell, ensuring correct orientation, with the positive terminal (+) facing upwards



Figure 16 – Coin Cell Orientation

Operation Manual

GEM and GEM PRO

- 7) Replace the pressure module, ensuring the connector on the Carrier PCB aligns with the socket on the base of the module.

Note: Care is to be taken when aligning

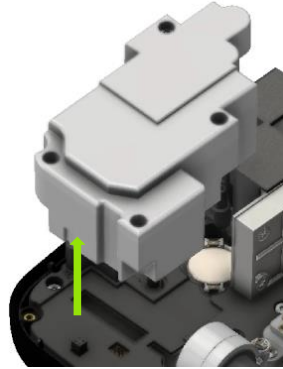

Figure 17 – Pressure Module Alignment

- 8) Replace the case back and secure it in place with the retained screws and the Phillips No.1 screwdriver



Figure 18 – Case Back Fitting

- 9) Tighten the inlet port plate screws using the Phillips No.1 screwdriver



Figure 19 – Inlet Port Plate Fitting

- 10) Place the replacement battery pack (QED part number PMMPB) into the case back recess. It will only fit one way and will automatically align itself.

GEM and GEM PRO

11) Using Phillips No. 1 screwdriver, secure the battery pack in place.



Figure 20 – Battery Fitting

12) i-Q is now ready to be switched on and used – see [Starting the i-Q](#).

Note: If the PMMPB battery is removed, the backup coin cell will maintain time/date settings and CO (H₂ compensated) cell conditioning for approximately 10 minutes. After this time, the user will have to reset the time & date and CO (H₂ compensated) cell conditioning will be affected, meaning the user may need to allow the cell to stabilize for 24 hours before use.

Note: It is the operator's responsibility to keep a record of when and what maintenance has been performed.

Note: In the event of malfunction or damage, please contact QED or an authorized representative.

Note: For further information please contact Technical Support at QED on:

QED Environmental Systems Ltd.

+44(0)333 800 0088

technical@qedenv.co.uk

QED Environmental Systems, Inc.

+1 (800) 624-2026

service@qedenv.com

AFFINITY

BATTERY REPLACEMENT



🔍 iQV14

The batteries in Affinity are user replaceable. When the batteries are getting low, the LED on the Affinity keypad will flash red slowly (see annotation 1 on [Figure 21](#)). When the battery is critically low, the LED in the Affinity keypad will flash red rapidly.

Operation Manual

GEM and GEM PRO



Figure 21 – Affinity

To replace the Affinity batteries:

- 1) Using the supplied Phillips No. 1 screwdriver, unscrew the two screws on the battery cover found on the rear of the case, and remove – see [Figure 22](#).

Note: The battery cover screws are retaining and should remain inside the cover.



Figure 22 – Affinity Battery Access

- 2) Remove the old batteries and dispose under the ordinance of the local authority.
- 3) Replace with 2 x AA Type Energizer® L91 cells.

Note: Ensure correct orientation of batteries.

- 4) Replace battery cover and using Phillips No. 1 screwdriver, secure cover in place.
- 5) Affinity is now ready to be switched on and paired with an i-Q instrument.

Note: It is the operator's responsibility to keep a record of when and what maintenance has been performed.

Note: In the event of malfunction or damage, please contact QED or an authorized representative.









CLEANING AND DECONTAMINATION

The equipment must have its battery removed prior to cleaning or decontamination. The enclosure can be cleaned externally using a mild soapy water and non-abrasive cloth.

Should the need arise for the i-Q instrument to be returned to QED, it is the responsibility of the owner to ensure that the instrument has been decontaminated or that QED has been made aware of any contaminants that may be present, prior to it being returned.

GEM and GEM PRO

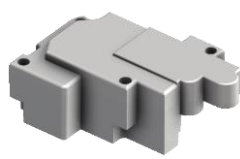
ACCESSORIES AND SPARES MODULES

Type	Option	Range	Part Number	Image
Infrared (select one)	CH ₄	100%	VMABI	
	CO ₂		VMBBI	
	CH ₄ & CO ₂		VMDBI	
Electrochemical	H ₂ S	50ppm	VMCF ⁴ PMCF ⁷	<div style="display: flex; flex-direction: column; align-items: center;"> <div style="display: flex; align-items: center; margin-bottom: 10px;"> 4-series  </div> <div style="display: flex; align-items: center; margin-bottom: 10px;"> 7-series  </div> <div style="display: flex; align-items: center;"> 5-series  </div> </div>
		200ppm	VMCG ⁴ PMCG ⁷	
		500ppm	VMCH ⁴	
		1,000ppm	VMCD ⁴ PMCD ⁷	
		5,000ppm	PMCI ⁷	
		10,000ppm	PMCA ⁷	
		40,000ppm	PMCI ⁷	
	CO	500ppm	VMGH ⁴ PMGH ⁷	5-series
		1,000ppm	VMGD ⁴	
		2,000ppm	VMGK ⁴	
	CO (H ₂ compensated)	2,000ppm	PMHK ⁵	
	H ₂	1,000ppm	VMID ⁴	
	NH ₃	1,000ppm	VMJD ⁴	
O ₂	25%	VMNT2		
Bypass	Bypass	None	BYPASS-MODULE	
Pressure	GEM PRO	High Flow	PMLLA	
	GEM			
	BIOGAS AD PRO			
	GA PRO	Low Flow	PMLMA	
	GA	No Flow	PMLNA	
	BIOGAS AD			
Battery	NiMH	10 hours	PMMPB	

Operation Manual
GEM and GEM PRO

ACCESSORIES

Description	Part Number	Image
Hard carry case	iQ-2.5	
Soft carry case	iQ-5.7	
Battery charger and adaptors (UK, US, AUS, EURO)	iQ-3.9	
Affinity (handheld wireless probes)	QED-AFFINITY	
AA Energizer® Lithium L91 (2 pcs) AA Energizer® Lithium L91 (10 pcs)	AFFINITY-AA AFFINITY-AA(10)	
Stylus	iQ-STYLUS	
Screwdriver (4-in-1)	iQ-TOOL	
Coin cell and removal tool	iQ-COINCELL	
Gas port faceplate	<i>Please contact QED</i>	
Anemometer (ATEX certified)	GF5.4	
Temperature probe (ATEX certified)	GF5.2	
H2S/Hydrocarbon filters	GA6.4 GA6.5	

GEM and GEM PRO

Description	Part Number	Image
<p>Check gas regulator and tubing for calibration gas. Calibration gas canister.</p> <p>Please contact us for available gas canister concentrations</p>	GA6.8	
<p>In-line water trap filter & tubing</p>	iQ-1.8	
<p>Water trap with barbed filters (10 pcs) Water trap with barbed filters (30 pcs)</p>	GA4.9 GA4.9(30)	
<p>PTFE filters for faceplate (10 pcs) PTFE filters for faceplate (30 pcs)</p>	iQ-FILTERS(10) iQ-FILTERS(30)	
<p>Gas ports connectors (10 pcs)</p>	MC10	
<p>Sampling tube 5m length flexible PVC tubing (3/16" id)</p>	GA2.3	

Operation Manual

GEM and GEM PRO

QUICK LINKS

QED DOWNLOADS



i-Q HELP



PATENT INFORMATION

The equipment in this manual is protected under U.S. and foreign patents issued and pending. For a complete list of patents visit www.graco.com/patents.

The equipment in this manual is protected under Registered Trademarks. For a complete list of Registered Trademarks and Trademarks, visit www.graco.com/trademarks.

GEM and GEM PRO

WARRANTY INFORMATION



i-Q Series Service, Care Pack & Module Replacement Terms and Conditions

SERVICE

1. Gas analyzer instruments (hereinafter "Instruments") returned for service will be completely inspected, serviced and calibrated by professionally trained technicians (hereinafter "Service").
2. For any issues caused by physical damage or Instrument misuse, a quotation will be issued by QED for approval prior to Service, which shall be paid via a separate purchase order.
3. At the time of Service, the Instrument will be updated to the latest Instrument-specific software (firmware), where feasible. This is not GAMSsoft software but specifically relates to instrument firmware. Certain Instruments may not be able to accept certain modifications, depending upon manufacture date and future product developments and technology.
4. A return authorization (RA) must be obtained from QED and supplied with the Instrument being returned for Service. Return Authorization is available from the website: [Service Return Form](#).
5. If the Instrument is greater than three (3) years old, it may be necessary to make additional charges to the agreed service sum to cover extra parts and labor. In such cases, the customer will be notified as soon as possible, and approval sought prior to the commencement of any Service.
6. All QED Standard Terms and Conditions of Sale apply. Available upon request.

FAST & EASY SERVICE

1. Customers will be quoted a flat rate repair fee, (based on analyzer model); at the time of request for a Return Authorization ([Service Return Form](#)).
2. Fast-N-Easy Inspection/Calibration/Repair for GEMPRO Portable Gas Analyzer includes, (as needed): CH4/CO2, O2 and up to two additional Cell Replacement, Firmware Updates, Replacement of Sensors, Transducers, Pump, Keypad, Lens, Tubing, USB Cable, Battery and Shipping Box. Also includes Water Trap Kit and Return Freight via Ground Transport..
3. If repairs are not included in the Fast & Easy contract, a new quote for the work will be issued and work will proceed once customer approval has been received.
4. Customer will then issue a purchase order, (or provide payment via credit card), for that flat rate fee and send instrument to QED with the issued RA.
5. QED will receive the instrument, inspect, repair, calibrate, test and ship it back to customer via Ground freight.
6. All parts, labor and return shipping charges, (Ground shipment only), are included in the flat rate fee. Additional charges will be added for taxes due and shipping charges for destinations outside North America.
7. There will be no additional charges and no delays due to quoting the repairs covered in the original Fast & Easy quote.



MODULE REPLACEMENT WITHOUT FAST & EASY

1. For customers who elect not to opt for factory service, modules should be purchased and replaced in line with the intervals stipulated by QED.
2. Modules are supplied on an exchange basis; once the module(s) have been replaced in the Instrument, the used module is to be returned. Receipt of the used module(s) at QED's Dexter, MI office is required within 30 calendar days of shipment date from QED to avoid being charged for the full replacement module amount. In the event the used module is not timely returned, a sales order for the replacement module will be raised and invoiced.

WARRANTY

QED warrants the equipment referenced below to be free from defects in material or workmanship on the date of delivery. QED will, for a period of three (3) years from the date of delivery, repair or replace (at QED's sole discretion) any goods determined by QED to be defective, subject to the following conditions:

- The model must be an i-Q Series - GEM, GEM PRO, GA, GA PRO, BIOGAS AD or BIOGAS AD PRO Instrument.
- The defect must be due to defects in materials or workmanship provided by QED.
- Proof of delivery/purchase must be provided to QED for any claims. This includes a QED sales order, invoice, or delivery note.
- All warranty repairs must be carried out by QED or its authorized agents. In certain circumstances, QED may grant prior written permission for the owner to replace a supplied part under warranty.
- Any repair or replacement component under warranty will not extend the warranty period of the Instrument itself.
- Modules must have been replaced and the Instrument connected to GAMSsoft, in each case as recommended and in line with the service intervals stipulated by QED on the Instrument.
- Where replacement parts have been supplied by QED under warranty, the defective parts must be returned to QED. If not returned, QED reserve the right to charge for the replacement part.
- If no defect is found by QED, an investigation charge may apply.
- QED's Technical Support Team **MUST** be notified in the event of a submitted warranty claim. QED's Technical Support Team will then issue a returns reference number that must be included in any return. Failure to provide this will void any warranty claim.
- This warranty is exclusive, and is in lieu of any other warranties, express or implied, including but not limited to warranty of merchantability or warranty of fitness for a particular purpose. QED's sole obligation and buyer's sole remedy for any breach of warranty shall be as set forth above. The buyer agrees that no other remedy (including, but not limited to, incidental or consequential damages for lost profits, lost sales, injury to person or property, or any other incidental or consequential loss) shall be available.

GEM and GEM PRO



THE FOLLOWING ARE NOT INCLUDED UNDER WARRANTY:

- Normal wear and tear of parts that wear out over time, or are consumed, is not covered. Such parts not covered include, but are not limited to, the PTFE filter and electro-chemical gas sensors/modules.
- Accidental damage, including dropping during use.
- Damage as a result of vandalism.
- Issues arising from use of the equipment that is not in accordance with standard operating procedures laid out in QED's operating manual(s).
- Issues arising from use of the equipment in unsuitable applications or in unsuitable environmental conditions.
- Repairs or alterations carried out by parties other than QED or its authorised agents.
- Any data stored on the Instrument.
- Issues due to a failure to maintain the Instrument in accordance with the operating manual.
- Any claimed business losses, including but not limited to claims for lost income, profits, and contracts (as far as the law allows).
- Any damages, including but not limited to consequential damages.

THE FOLLOWING VOIDS THE WARRANTY:

- Non-approved QED parts being used for repair or maintenance.
- When parts are added, or repairs or alterations made to the Instrument outside the scope of the operating manual.
- The Instrument having been stored or installed outside of the operating range and environmental conditions determined in the operating manual.
- The Instrument has not been maintained in accordance with the operating manual.

SERVICE WARRANTY:

- QED offers a three (3)-month service warranty period, following Service ("Service Warranty"). This Service Warranty will not apply if failure is due to misuse, abuse or negligence.
- QED warrants that: (a) all QED personnel assigned to perform Service(s) will have the necessary skill and training; and (b) Service(s) will be performed in a manner consistent with the standard of care in the industry; and (c) Service(s) will be performed in accordance with QED's specifications. The Service Warranty will begin on the date of Service completion and will be valid for a period of ninety (90) days thereafter ("Service Warranty Period").
- This warranty is exclusive, and is in lieu of any other warranties, express or implied, including but not limited to warranty of merchantability or warranty of fitness for a particular purpose. QED's sole obligation and buyer's sole remedy for any breach of warranty shall be as set forth above. The buyer agrees that no other remedy (including, but not limited to, incidental or consequential damages for lost profits, lost sales, injury to person or property, or any other incidental or consequential loss) shall be available.

Note: Warranty repair is only granted after an investigation by QED.

Note: For assistance in determining if your equipment qualifies for warranty investigation, please contact your local distributor, or our Technical Support Team at QED on 800-624-2026 or email at service@qedenv.com.

QED Environmental Systems reserve the right to update these Terms and Conditions without notice.

Note: For the latest terms and conditions, please refer to our website www.qedenv.com



www.qedenv.com

QED Environmental Systems Inc.

2355 Bishop Circle West

Dexter, MI 48130 - 1592

1 (800) 624 – 2026

info@qedenv.com

QED Environmental Systems Ltd.

Unit 3 – Cyan Park

Coventry

United Kingdom

+44 (0) 333 800 0088

sales@qedenv.co.uk